

SPECIFICATIONS FOR LCD MODULE

CUSTOMER	
MODEL	SCT024015-V01
CUSTOMER APPROVED	

APPROVED BY	CHECKED BY	ORGANIZED BY
	Lr.Yin	Wf.Luo

ADD : 2nd Floor,Block B,XinKeJu Machinery Manufacturing Co.,Ltd.No.208

MeiJingXi Road,SongMuShan,DaLang Town,DongGuan City,China

TEL : 0769-84428017

FAX : 0769-84428017



0158

RECORDS OF REVISIONS

Revision No	Revision Date	Description
Ver: A0	2017-01-18	First release
Ver: A1	2017-03.21	Modify outline

CONTENTS

- General Description
- Interface Timing
- Electrical Characteristics
- Optical characteristics
- Reliability
- Precaution
- Outline Dimension
- Packing method

1. General Description

This LCM [SCT024015-V01](#) is a TFT LCD module, comprising a [720](#)-channel source driver, a [320](#)-channel gate driver, [240 \(RGB\) x 320](#) dots graphic, and power supply circuit. The 262k color can be display.

This TFT-LCD has [2.4](#) inch diagonally measured active display area with [QVGA](#) resolution.

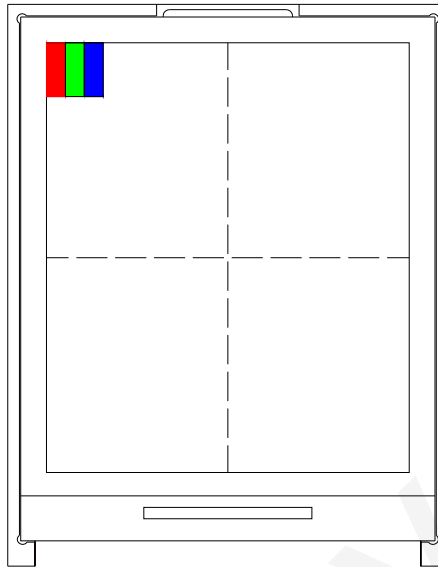

1.1 Mechanical Specifications

Item	Nominal Dimension	Unit
Dot Matrix	240 x RGB x 320	Dots
Module Size (W×H×T)	42.72 x 60.26 x 2.45	mm.
Active Area (W×H)	36.72 x 48.96	mm.
Pixel arrangement	RGB Stripe	mm.
Dot Pitch (W×H)	0.153 x 0.153	mm.
Color depth	262K (MAX)	colors
Interface	4-line SPI	-
Driving IC Package	COG	-

1.2 Display Specifications

Item	Nominal Dimension	Unit
Operating temperature	-20 ~70	°C
Storage temperature	-30~80	°C
LCD Type	a-Si TFT	-
LCD Mode	TN/Normal White	-
Backlight Type	LED x 4	PCS

1.3 Block Diagram

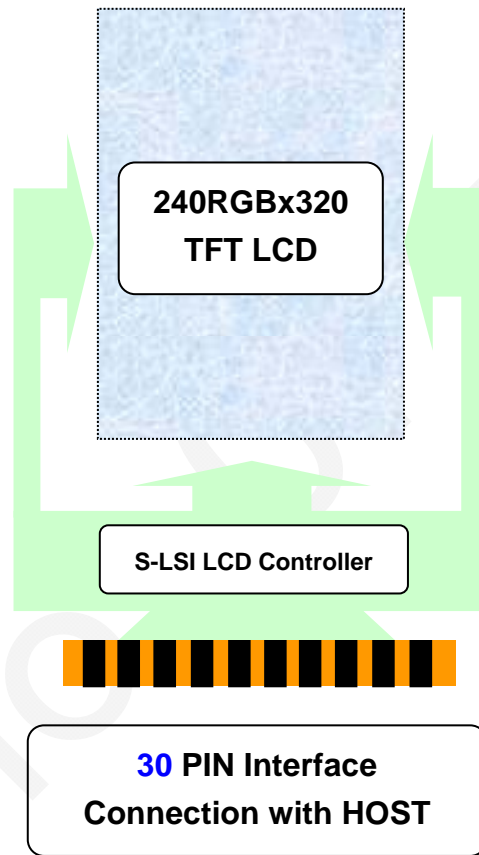

1.4 Back-light Unit

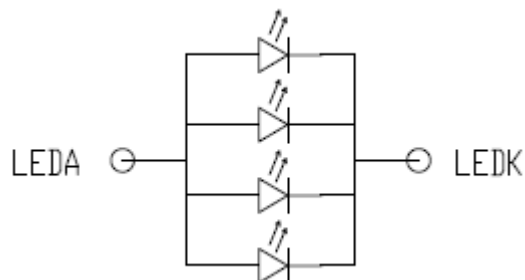

1.5 Interface Pin

Pin No	Pin Symbol	Level	Description
1	GND	0V	Ground
2	RS	H/L	Command / parameter or display data selection 0: Command or parameter 1: Display data
3	CS	0V	Chip select
4	SCL	H/L	SPI clock
5	SDA	H/L	SPI data
6	RESET	H/L	Reset signal
7	VCC	2.8-3.2V	Power supply
8	GND	0V	Ground
9	LEDA	-	LED light, anode
10	LEDK	-	LED light, cathode.
11-30	NC	-	No connect

2. Interface Timing

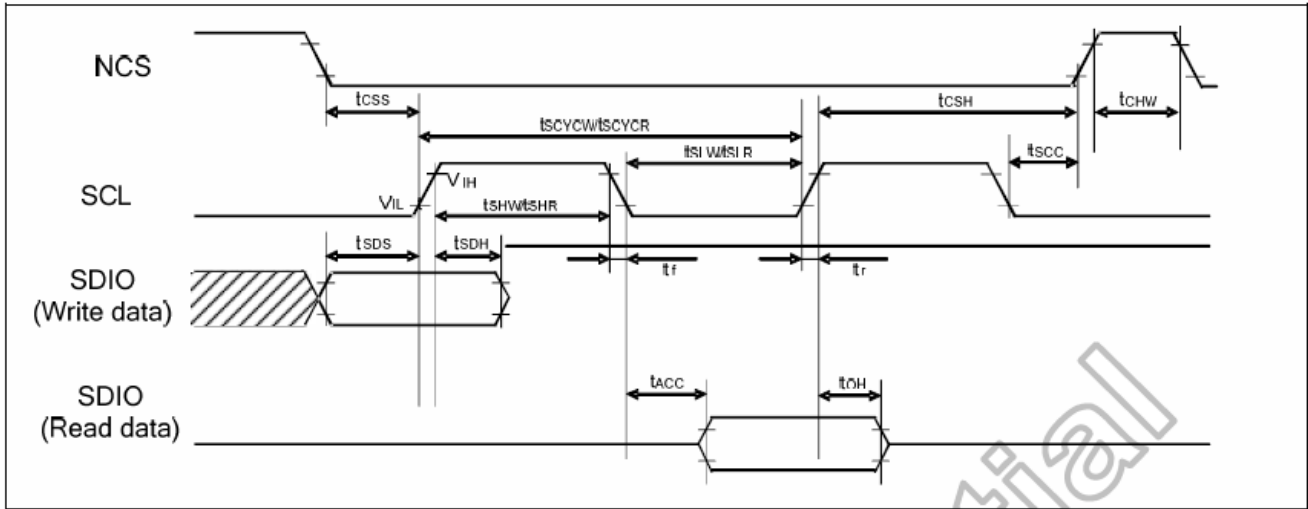

Figure 8-4: Serial interface characteristics

(VSSA=0V, IOVCC=1.65V to 3.3V, VCI=2.3V to 3.3V, TA=-30 to 70° C)

Parameter	Symbol	Conditions	Spec.			Unit
			Min.	Typ.	Max.	
Serial clock cycle (Write)	tSCYCW		14	-	-	
SCL "H" pulse width (Write)	tSHW	SCL	6	-	-	ns
SCL "L" pulse width (Write)	tSLW		6	-	-	
Data setup time (Write)	tSDS	SDA	6	-	-	ns
Data hold time (Write)	tSDH		6	-	-	
Serial clock cycle (Read)	tSCYCR		150	-	-	
SCL "H" pulse width (Read)	tSHR	SCL	60	-	-	ns
SCL "L" pulse width (Read)	tSLR		60	-	-	
Access Time	tACC	SDI for maximum CL=30pF For minimum CL=8pF	10	-	50	ns
Output disable time	tOH	SDO For maximum CL=30pF For minimum CL=8pF	15	-	50	ns
SCL to Chip select	tSCC	SCL, NCS	20	-	-	ns
NCS "H" pulse width	tCHW	NCS	40	-	-	ns
Chip select setup time	tCSS	NCS	15	-	-	ns
Chip select hold time	tCSH		15	-	-	ns

Note: The input signal rise time and fall time (tr, tf) is specified at 15 ns or less.

Logic high and low levels are specified as 30% and 70% of IOVCC for Input signals.

Input Signal Slope

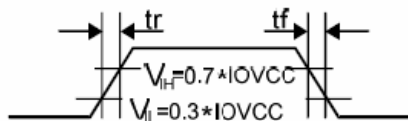

Output Signal Slope

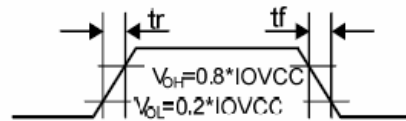

3. Electrical Characteristics

3.1 Absolute Maximum Ratings

Item	Symbol	Min	Max	Unit
Supply voltage for System	VCC	0	4.6	V
Supply voltage for Interface Operation	VCC	0	4.6	V
Operate temperature range	TOP	-20	70	°C
Storage temperature range	TST	-30	80	°C

Note:

- (1) 90%RH maximum humidity, 60°C maximum wet-bulb temperature When operated at a temperature lower than 0°C, the LCD worked slowly and the screen appeared low-contrast images due to the characteristics of LC(Liquid Crystal).
- (2) If any fixed pattern is displayed on LCD for minutes, image-sticking phenomenon may occur.
- (3) Degradation could occur to pixels' TFT when DC BIOS is input into its gate-signal under POWER OFF WAITING STAND-BY & SLEEP MODE. Therefore, LCD should be turn off then.
- (4) Please operate a LCD module on the basis of the recommended S/W(Register)

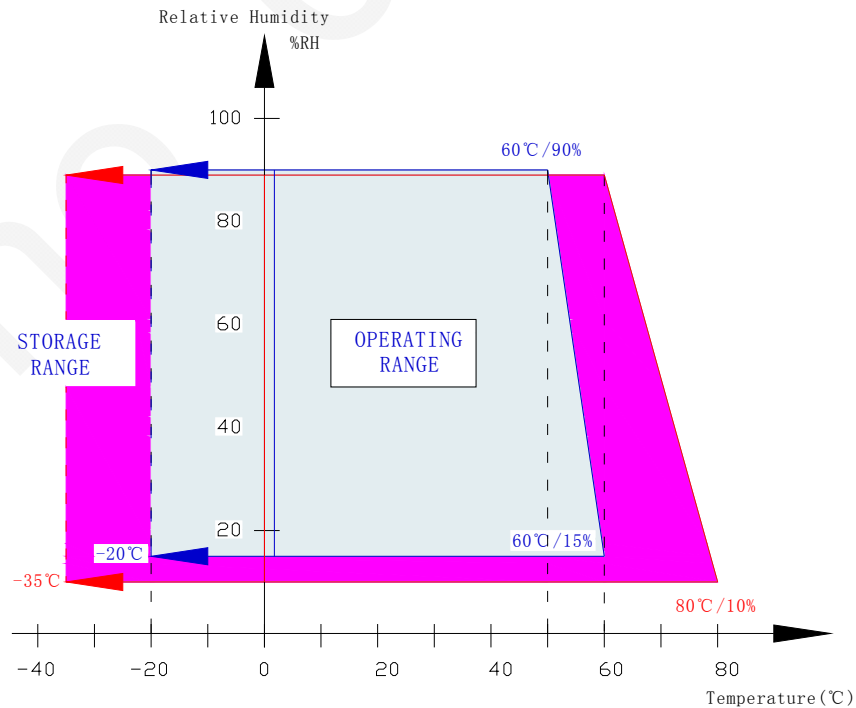

Temperature & Humidity Graph at Absolute Environment

DATA). If you want to change any part of the S/W, you must take driver's confirmation.

3.2 DC Characteristics

$T_a = 25^\circ\text{C}$

Item	Symbol	Min	Typ	Max	Unit	Condition
Supply voltage for System	VCC	2.3	2.8	3.3	V	
Supply voltage for Interface Operation	VCC	2.3	2.8	3.3	V	
Input high level voltage	V_{IH}	0.8VDD	--	VDD	V	
Input low level voltage	V_{IL}	0	--	0.2VDD	V	
Power supply current	$I_{CC} + I_{CI}$	--	TBD	--	mA	
Backlight forward voltage	V_F	2.75	3.2	3.6	V	
Backlight forward current	I_F	--	80	--	mA	
Backlight Uniformity	Avg	80	85	--	%	

4. Optical characteristics

Parameter		Symbol	Condition	Min	Typ	Max	Unit	Note
Viewing angle		Left	$CR \geq 10$		45		Degree	(2)
		Right			45		Degree	
		Up			45		Degree	
		Down			20		Degree	
Color Chromaticity	Red	R_x	$\theta = 0$ Normal viewing angle	0.592	0.612	0.632	-	Color Chromaticity
		R_y		0.309	0.329	0.349	-	
	Green	G_x		0.279	0.299	0.319	-	
		G_y		0.547	0.567	0.587	-	
	Blue	B_x		0.124	0.144	0.164	-	
		B_y		0.090	0.110	0.130	-	
	White	W_x		0.288	0.308	0.328	-	
		W_y		0.305	0.325	0.345	-	
Contrast ratio		CR	optimal	-	250		-	(1)
Response time		$Tr + Tf$			30		ms	(3)
Luminance on surface $I_f = 80\text{mA}$		L_v	Normally $\theta_x = \theta_y = 0$	300	350		cd/m^2	

Note (1) Definition of contrast ratio

Measured at the center point of panel

$$CR = \frac{\text{Luminance with all pixel white}}{\text{Luminance with all pixel black}}$$

Note (2) Definition of viewing angle

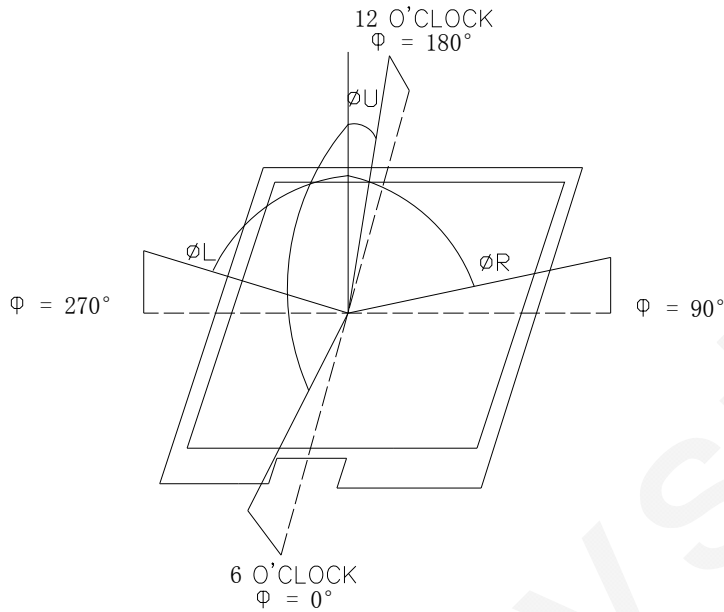

Note (3) Definition of response time: $T_r + T_f$

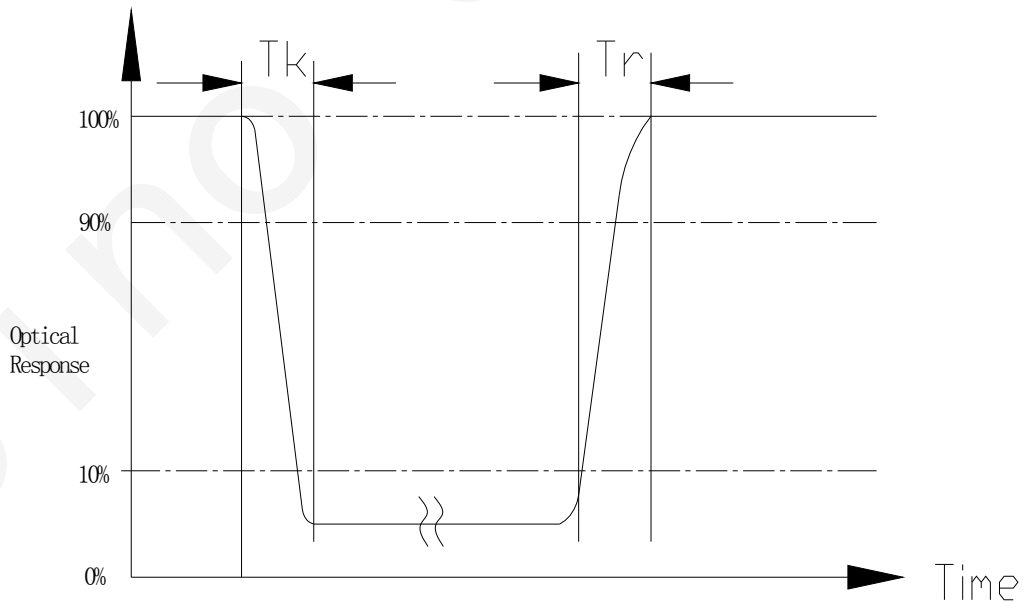

5. Reliability

5.1 Reliability Condition

Item No	Item	Condition	Remark
1	High temperature Operating	60°C, 120Hours	Finish product (With polarizer)
2	Low temperature Operating	-10°C, 120 Hours	Finish product (With polarizer)
3	High temperature Storage	70°C, 200 Hours	Finish product (With polarizer)
4	Low temperature Storage	-20°C, 200 Hours	Finish product (With polarizer)
5	High temperature & humidity Storage	50°C, 90%RH, 120 Hours	Finish product (With polarizer)
6	Thermal Shock Storage (No operation)	-10°C , 30min.<=> 60°C , 30min. 10 Cycles	Finish product (With polarizer)
7	ESD test	Voltage:±8KV R:330 ohm,C:150pF Air discharge,10 times	Finish product (With polarizer)
8	Vibration test	10 => 55 =>10 => 55 => 10 Hz, within 1 minute;Amplitude:1.5mm. 15 minutes for each Direction (X,Y,Z)	Finish product (With polarizer)
9	Drop test	Packed, 100CM free fall 6 sides, 1 corner, 3edges	Finish product (With polarizer)

*One single product test for only one item.

* Judgment after test: keep in room temperature for more than 2 hours.

- Current consumption < 2 times of initial value
- Contrast > 1/2 initial value
- Function: work normally

5.2 Inspection plan

Class	Item	Judgment	Class
Packing & Indicate	1.Outside and inside package	"Model no." , "lot no." and "quantity" Should indicate on the package.	Minor
	2.Model mixed and quantity	Other model mixed.....rejected. Quantity short or over....rejected.	Critical
	3.Product indication	"Model no." should indicate on the product	Major
Assembly	4.Dimension,LCD glass scratch And scribe defect	According to specification or drawing	Major
Appearance	5.Viewing area	Polarizer edge or LCD's sealing line is visible in the viewing arearejected	Minor
	6.Blemish 、 black spot 、 White spot in the LCD And LCD glass cracks	According to standard of visual inspection (inside viewing area)	Minor
	7. Blemish 、 black spot White spot and scratch on the polarizer	According to standard of visual inspection (inside viewing area)	Minor
	8.Bubble in polarizer	According to standard of visual inspection (inside viewing area)	Minor
	9.LCD's rainbow color	Strong deviation color (or Newton ring) of LCDrejected. Or according to limited sample (if needed, and inside viewing area)	Minor
	10.FPC	Burned area or wrong part number is on FPC. The symbol, character, and mark of FPC are unidentifiable. The stripped solder mask, A>1.0mm 0.3mm < stripped solder mask or visible circuit, A<1.0mm,and the number is ≧ 4 pieces. Particle between circuits in solder mask.. Circuit is peeled off or cracked. Any circuit risen or exposed. 0.2mm< Area of solder ball, A is ≧0.4mm,the number of solder ball is ≧ 3 pieces. The magnitude of solder ball, A is>0.4mm.	Minor

5.3 Standard of visual inspection

Class	Item	Judgment	Class
Electrical	11. Electrical and optical characteristics (contrast、VOP、chromaticity...etc)	According to specification or drawing. (inside viewing area)	Critical
	12. Missing pattern	Missing dot、line、character.....rejected	Critical
	13. Short circuit、wrong pattern display	Non display、wrong pattern display、current consumption out of specification.....rejected	Critical
	14. Pin hole、pattern deformity	According to standard of visual inspection	Minor
	15. Black spot、white spot、black line、white line、slant line、background uneven、color uneven	Strong deviation color.....rejected Or according to limited sample full off screen (all black) ...disregards	Minor
	16. Stick image (retention image)	Fixed test picture within two hours...rejected	Minor

Class	Item	Judgment																			
Minor	<ul style="list-style-type: none"> Blemish、black spot、white spot in the LCD. Blemish、black spot、white spot and scratch on th polarizer 	<p>(A) Round type: unit: mm</p> <table border="1"> <thead> <tr> <th>Diameter (mm.)</th> <th>Acceptable Q'ty</th> </tr> </thead> <tbody> <tr> <td>$0.2 < A$</td> <td>0</td> </tr> </tbody> </table> <p>Note: $A = (\text{Length} + \text{Width}) / 2$</p> <p>(B) Liner type: unit: mm</p> <table border="1"> <thead> <tr> <th>Length</th> <th>Width</th> <th>Acceptable Q'ty</th> </tr> </thead> <tbody> <tr> <td>---</td> <td>$W \leq 0.03$</td> <td>Disregard</td> </tr> <tr> <td>$L \leq 5$</td> <td>$0.03 < W \leq 0.05$</td> <td>3</td> </tr> <tr> <td>$L \leq 5$</td> <td>$0.05 < W \leq 0.07$</td> <td>1</td> </tr> <tr> <td>---</td> <td>$0.07 < W$</td> <td>Follow round type</td> </tr> </tbody> </table>	Diameter (mm.)	Acceptable Q'ty	$0.2 < A$	0	Length	Width	Acceptable Q'ty	---	$W \leq 0.03$	Disregard	$L \leq 5$	$0.03 < W \leq 0.05$	3	$L \leq 5$	$0.05 < W \leq 0.07$	1	---	$0.07 < W$	Follow round type
		Diameter (mm.)	Acceptable Q'ty																		
$0.2 < A$	0																				
Length	Width	Acceptable Q'ty																			
---	$W \leq 0.03$	Disregard																			
$L \leq 5$	$0.03 < W \leq 0.05$	3																			
$L \leq 5$	$0.05 < W \leq 0.07$	1																			
---	$0.07 < W$	Follow round type																			
Minor	Bubble in polarizer	<p>unit: mm</p> <table border="1"> <thead> <tr> <th>Diameter</th> <th>Acceptable Q'ty</th> </tr> </thead> <tbody> <tr> <td>$A \leq 0.3$</td> <td>Disregard</td> </tr> <tr> <td>$0.3 < A \leq 0.5$</td> <td>1</td> </tr> <tr> <td>$0.5 < A$</td> <td>0</td> </tr> </tbody> </table>	Diameter	Acceptable Q'ty	$A \leq 0.3$	Disregard	$0.3 < A \leq 0.5$	1	$0.5 < A$	0											
Diameter	Acceptable Q'ty																				
$A \leq 0.3$	Disregard																				
$0.3 < A \leq 0.5$	1																				
$0.5 < A$	0																				
Minor	Pin hole、Pattern deformity	<p>unit: dot size</p> <table border="1"> <thead> <tr> <th>Diameter</th> <th>Acc. Q'ty</th> </tr> </thead> <tbody> <tr> <td>$0.4 < \Phi$</td> <td>0</td> </tr> </tbody> </table>	Diameter	Acc. Q'ty	$0.4 < \Phi$	0															
Diameter	Acc. Q'ty																				
$0.4 < \Phi$	0																				

6. Precaution

6.1 Handling

- (1) Protect the panel from static, it may cause damage to the CMOS Gate Array IC.
- (2) Use fingerstalls with soft gloves in order to keep display clean during the incoming inspection and assembly process.
- (3) If the liquid crystal material leaks from the panel, it should be kept away from the eyes or mouth. In case of contact with hands, legs or clothes, it must be washed away thoroughly with soap.
- (4) The desirable cleaners are water, IPA (Isopropyl Alcohol) or Hexane. Don't use Ketone type materials (ex. Acetone), Ethyl alcohol, Toluene, Ethyl acid or Methyl chloride. It might permanent damage to the polarizer due to chemical reaction.
- (5) Pins of I/F connector shall not be touched directly with bare hands.
- (6) Refrain from strong mechanical shock and / or any force to the panel. In addition to damage, this may cause improper operation or damage to the panel.
- (7) Note that polarizers are very fragile and could be easily damaged. Do not press or scratch the surface harder than a B pencil lead.
- (8) Wipe off water droplets or oil immediately. If you leave the droplets for a long time, staining and discoloration may occur.
- (9) If the surface of the polarizer is dirty, clean it using some absorbent cotton or soft cloth.

6.2 Storage

- (1) Do not leave the panel in high temperature, and high humidity for a long time. It is highly recommended to store the panel with temperature from 0 to 35°C and relative humidity of less than 70%.
- (2) The panel shall be stored in a dark place. It is prohibited to apply sunlight or fluorescent light during the store.

6.3 Operation

- (1) The LCD shall be operated within the limits specified. Operation at values outside of these limits may shorten life, and/or harm display images.
- (2) Do not exceed the absolute maximum rating value. (the supply voltage variation, Input voltage variation in part contents and environmental temperature and so on). Otherwise the panel may be damaged.
- (3) If the panel displays the same pattern continuously for a long period of time, it can be the situation when the image" Sticks" to the screen.

7. Outline Dimension

Refer to SCT024015-V01 drawing.

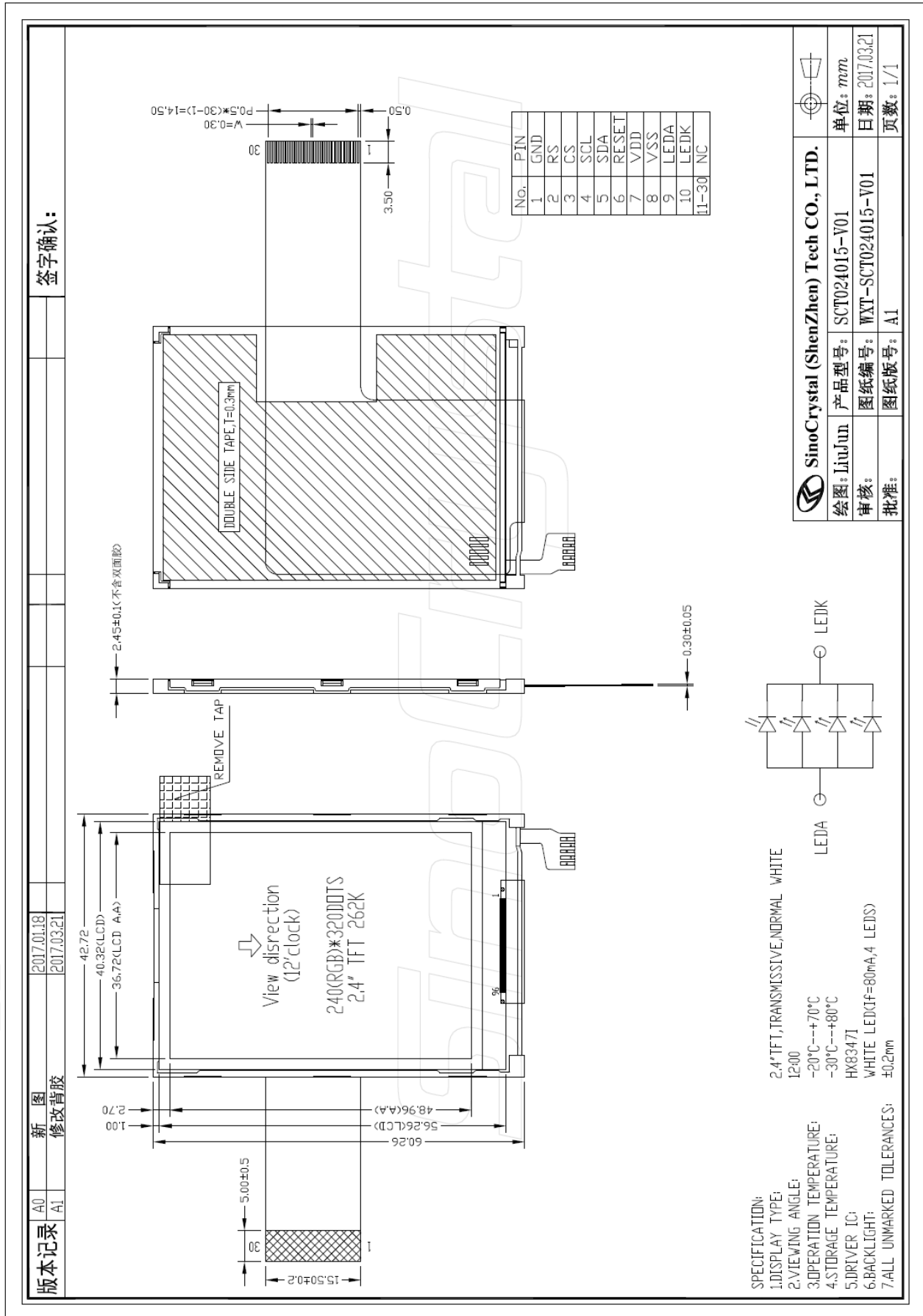

8. Packing method

8.1 Packing Quantity (TBD)

8.2 Flowing chart (TBD)

SinoCrystal