

SPECIFICATIONS FOR LCD MODULE

CUSTOMER	
MODEL	SCT043006-V02
CUSTOMER APPROVED	

APPROVED BY	CHECKED BY	ORGANIZED BY
	Lr.Yin	Wf.Luo

ADD: 2nd Floor,Block B,XinKeJu Machinery Manufacturing Co.,Ltd.No.208 MeiJingXi Road,SongMuShan,DaLang Town,DongGuan City,China

TEL: 0755-81452160

FAX: 0755-81452166



0158

Specification Revision History

Version	Content	Date
A0	First Issue	19-Sep-2018
A1	Revision mechanical dimensions	14-Dec-2018

CONTENTS

- **MODULE CLASSIFICATION INFORMATION**
- **PHYSICAL DATA**
- **MECHANICAL DIMENSIONS**
- **BLOCK DIAGRAM**
- **INTERFACE PIN CONNECTIONS**
- **ABSOLUTE MAXIMUM RATINGS**
- **ELECTRICAL CHARACTERISTICS**
- **BACKLIGHT**
- **OPTICAL CHARACTERISTICS**
- **OPERATING PRINCIPLES & METHODS**
- **RELIABILITY**
- **INSPECTION CRITERIA**
- **PRECAUTIONS FOR USING LCD MODULES**
- **USING LCD MODULES**

MODULE CLASSIFICATION INFORMATION

PHYSICAL DATA

ITEM	STANDARD VALUE	UNIT
NUMBER OF GRAPHIC	480(RGB)×272	Mm
MODULE DIMENSION	114.3×83.8×4.45	Mm
EFFECTIVE DISPLAY AREA	95.040×53.856	Mm
DOT SIZE	-	Mm
DOT PITCH	0.198×0.198	Mm
LCD TYPE	TFT , Transmissive, Normal White, INNOLUX Panel F043A11	
DUTY	-	
VIEWING DIRECTION	6:00	o'clock
BACK LIGHT TYPE	SIDE-LIT LED	
BACK LIGHT COLOR	WHITE	
APPROX. WEIGHT	-	G

MECHANICAL DIMENSIONS

Version	A0 new version	2018.09.19							
	A1 Revision backlight information	2018.12.14							Confirm:

1	LEDK
2	LEDA
3	VSS
4	VDD
5	R0
6	R1
7	R2
8	R3
9	R4
10	R5
11	R6
12	R7
13	G0
14	G1
15	G2
16	G3
17	G4
18	G5
19	G6
20	G7
21	B0
22	B1
23	B2
24	B3
25	B4
26	B5
27	B6
28	B7
29	VSS
30	PCLK
31	PDN
32	HSYNC
33	VSYSNC
34	DE
35	NC
36	VSS
37	NC(XR)
38	NC(YD)
39	NC(XL)
40	NC(YT)

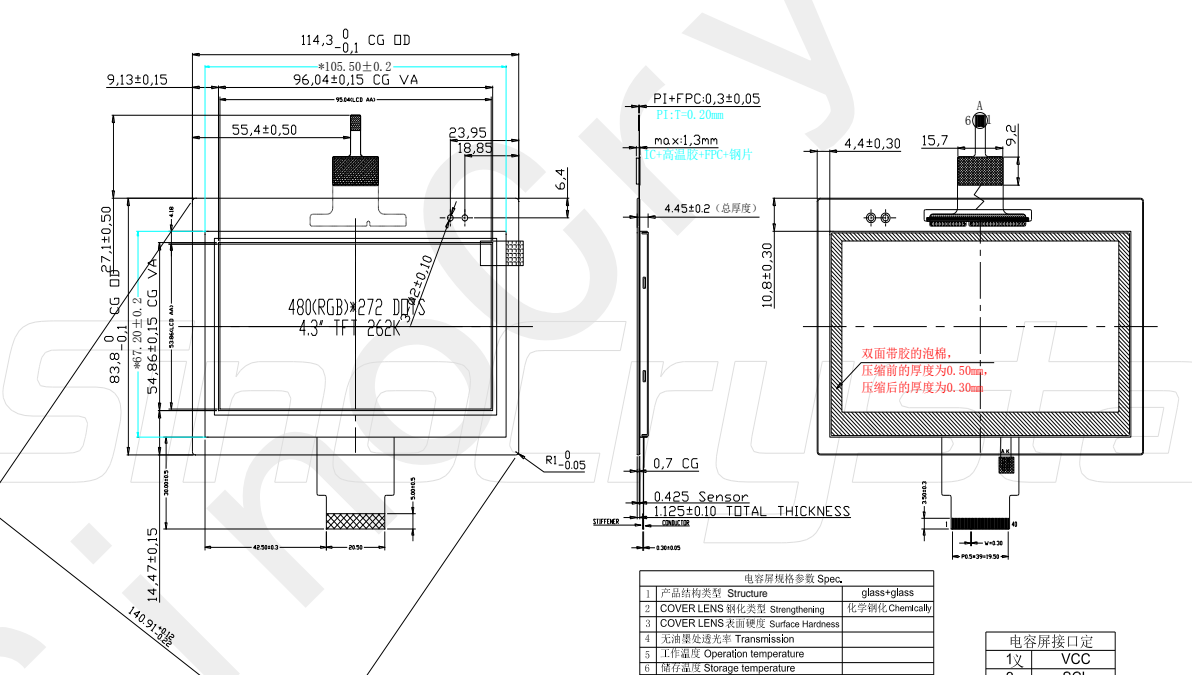

Top view labels: 114.3⁰_{-0.1} CG DD, 96.04±0.15 CG VA, 9.13±0.15, 55.4±0.50, 23.95, 18.85, 6.4, 480(RGB)×272 DOTS, 4.3" TFT, 262K, 83.8⁰_{-0.1} CG DD, 47.20±0.2, 54.86±0.15 CG VA, 14.47±0.15, 14.0, 91.3±0.15, 14.0, 91.3±0.15, 42.5±0.3, 20.50, R1⁰_{-0.05}, 0.7 CG, 1.125±0.10 TOTAL THICKNESS, 1.3±0.09

Side view labels: PI+FPC:0.3±0.05, PI:T=0.20mm, max:1.3mm, C=高温胶+FR+铜片, 4.45±0.2 (总厚度), 4.4±0.30, 15.7, 10.8±0.30, 0.425 Sensor, 0.7 CG

Notes: 双面带胶的泡棉, 压缩前的厚度为0.50mm, 压缩后的厚度为0.30mm

电容屏规格参数 Spec.		
1 产品结构类型 Structure	glass+glass	
2 COVER LENS 钢化类型 Strengthening	化学钢化 Chemically	
3 COVER LENS 表面硬度 Surface Hardness		
4 无油膜透光率 Transmission		
5 工作温度 Operation temperature		
6 储存温度 Storage temperature		
所有产品物料满足ROHS和无卤素要求		
*All materials comply with ROHS		
触控IC 型号 Touch IC	GT9111	通道数 Channels 17*10
供电电压 VDD	3.3V	通讯电压 IIC Voltage 3.3V
DA: SCL 主板上是否有上拉电阻 resistance on SDA SCL main board	是	

SPECIFICATION:

1.DISPLAY TYPE: 4.3" TFT, TRANSMISSIVE, NORMAL WHITE, PF051-E043

2.VIEWING ANGLE: 6:00(Gray Inversion) 12:00(Human Eye)

3.OPERATION TEMPERATURE: -20°C-- +70°C

4.STORAGE TEMPERATURE: -30°C-- +80°C

5.DRIVER IC: S17282

6.BACKLIGHT: WHITE LED(I_f=20mA, 8 LEDS) (99-616KLM2C/L8792SGU/TR8-T or Equivalent)

7.ALL UNMARKED TOLERANCES: ±0.2mm

LEDK ← LEDA

SinoCrystal (ShenZhen) Tech CO., LTD.		
Draw: LiuJun	Part NO.: SCT043006-V02	Unit: mm
Check:	Draw NO.: WXT-SCT043006-V02	Date: 2018.12.14
Approve:	Draw Ver: A1	Page: 1/1

NOTES: TOLERANCES UNLESS OTHERWISE SPECIFIED: ±0.20 mm

■DIAGRAM

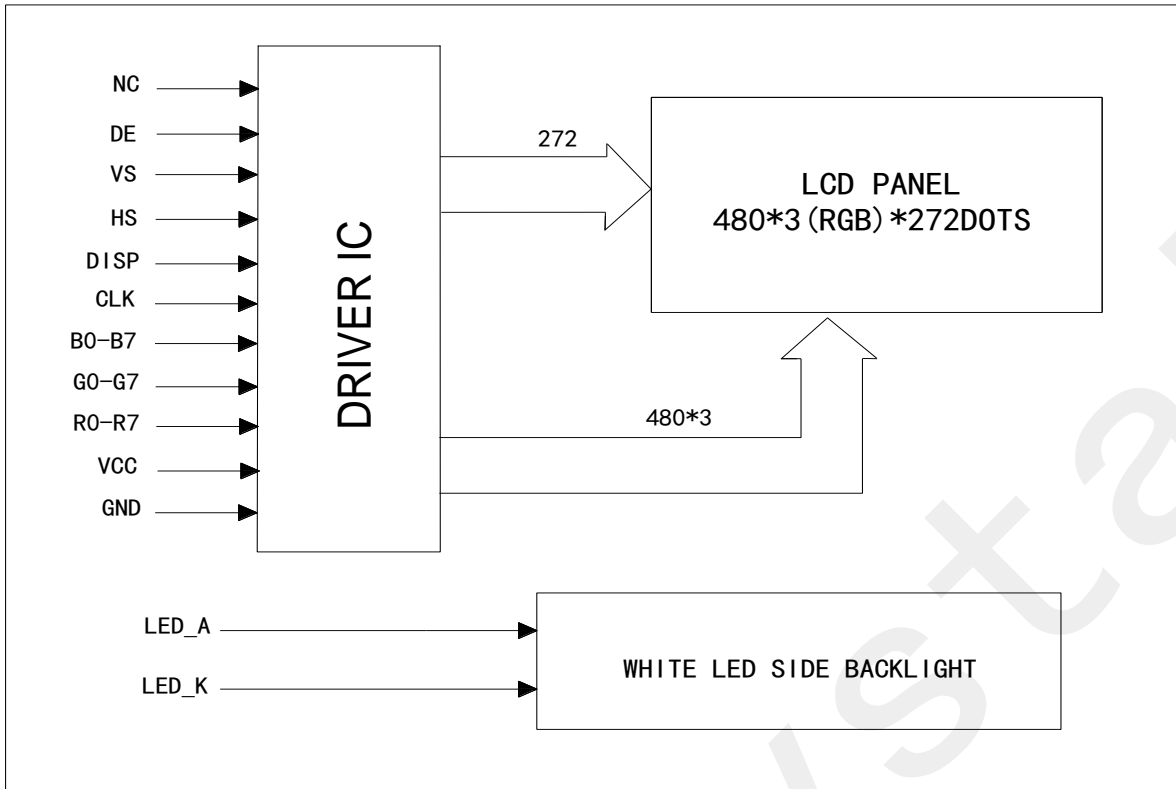

■ INTERFACE PIN CONNECTIONS

NO	SYMBOL	LEVEL	FUNCTION
1	LEDK	-	LED light,cathode
2	LEDA	-	LED light,anode
3	GND	-	Ground
4	VCC	-	Power supply
5	R0	H/L	<p>Graphic Data Input Pins. Internal pull low.</p> <ul style="list-style-type: none"> - R [7:0]: Red Data - 8-bits - G [7:0]: Green Data -8-bits - B [7:0]: Blue Data - 8-bits
6	R1	H/L	
7	R2	H/L	
8	R3	H/L	
9	R4	H/L	
10	R5	H/L	
11	R6	H/L	
12	R7	H/L	
13	G0	H/L	
14	G1	H/L	
15	G2	H/L	
16	G3	H/L	
17	G4	H/L	
18	G5	H/L	
19	G6	H/L	
20	G7	H/L	
21	B0	H/L	
22	B1	H/L	
23	B2	H/L	
24	B3	H/L	
25	B4	H/L	
26	B5	H/L	
27	B6	H/L	
28	B7	H/L	
29	GND	H/L	Ground
30	CLK	H/L	Clock signal
31	DISP	H/L	Display on/off
32	HS	H/L	Horizontal sync input in RGB mode
33	VS	H/L	Vertical sync input in RGB mode
34	DE	H/L	Data enable
35	NC	-	No used
36	GND	-	Ground
37	NC(XR)	-	No used (Touch panel right)
38	NC(YD)	-	No used (Touch panel bottom)
39	NC(XL)	-	No used (Touch panel left)
40	NC(YT)	-	No used (Touch panel top)

■ ABSOLUTE MAXIMUM RATINGS

PARAMETER	SYMBOL	MIN	MAX	UNIT
Supply voltage for logic	VCC	0	4.6	V
Operating temperature	TOP	-20	+70	°C
Storage temperature	TST	-30	+80	°C

■ ELECTRICAL CHARACTERISTICS

▼ DC Characteristics

Condition: VCC=3.3V, VSS=0V, Ta=25°C

PARAMETER	SYMBOL	CONDITION	MIN	TYP	MAX	UNIT
Supply voltage	VCC	----	3.0	3.3	3.6	V
Input Current	I _{dd}	At Black pattern	---	15	20	Ma
Input voltage 'H' level	V _{IH}		0.7VCC	---	VCC	V
Input voltage 'L' level	V _{IL}		0	---	0.3VCC	V
Output voltage 'H' level	V _{OH}		VCC-0.4	---	VCC	V
Output voltage 'L' level	V _{OL}		0	---	0.4	V

▼ AC Characteristics

Parallel 24 Bit RGB Mode

(VCC=3.3V, GND= 0V, TA=25°C)

Parameter	Symbol	Spec.			Unit
		Min	Typ	Max	
Clock cycle	Fclk	8	9	12	MHZ
Hsync cycle	1/th	---	17.14	---	KHZ
Vsync cycle	1/tv	---	59.94	---	Hz
Horizontal Signal					
Horizontal cycle	th	525	525	605	CLK
Horizontal display period	thd	480	480	480	CLK
Horizontal front porch	thf	2	2	82	CLK
Horizontal pulse width	thp	2	41	41	CLK
Horizontal back porch	thb	2	2	41	CLK
Vertical signal					
Vertical cycle	tv	285	286	399	H(1)
Vertical display period	tvd	272	272	272	H(1)
Vertical front porch	tvf	1	2	227	H(1)
Vertical pulse width	tvp(2)	1	10	11	H(1)
Vertical back porch	tvb(2)	1	2	11	H(1)

Note(1)Unit:CLK=1/ Fclk,H=th,

(2)It is necessary to keep tvp+tvb=12 and thp+thb=43 in sync mode. DE mode is unnecessary to keep it.

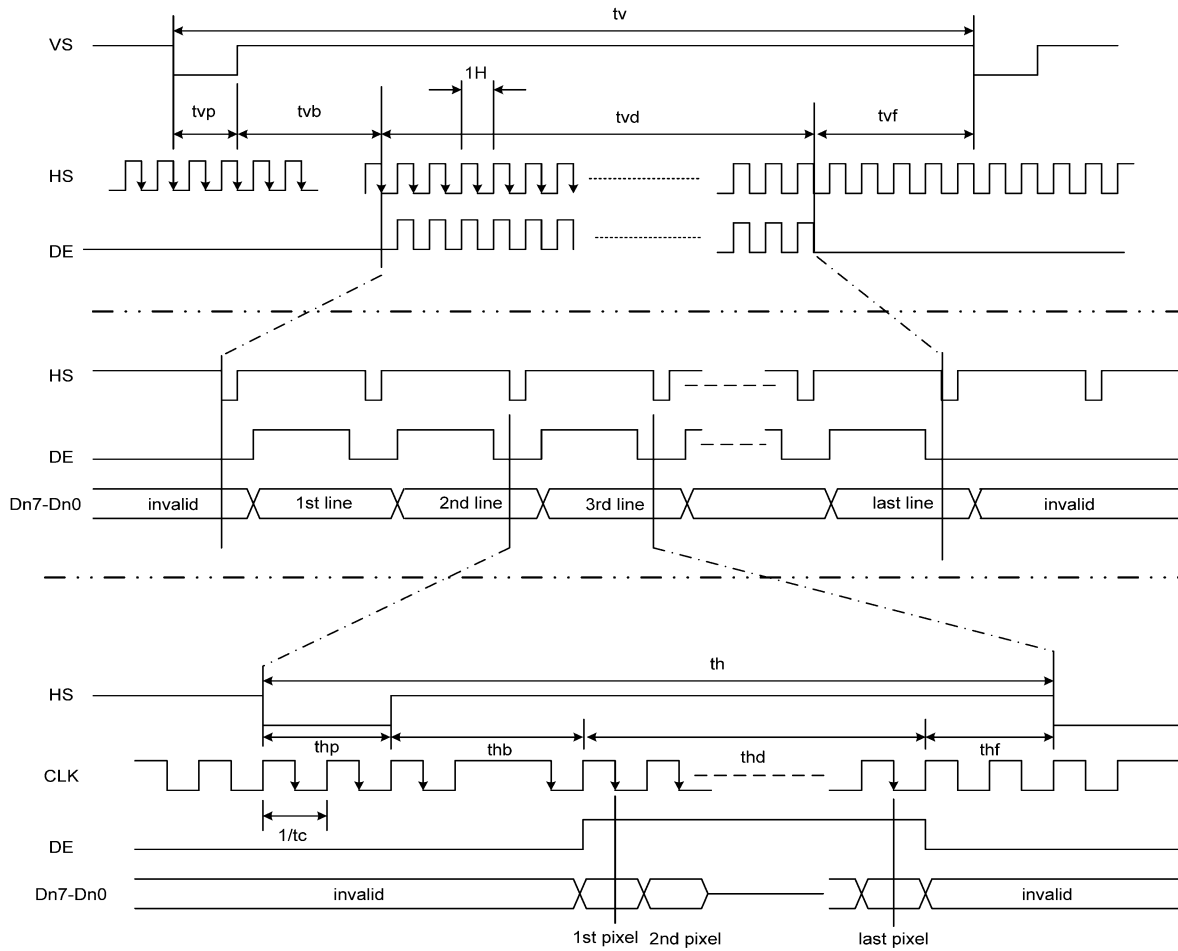

Serial RGB input timing requirement

Parameter	Symbol	Spec.			Unit
		Min	Typ	Max	
Clock cycle	Fclk(3)	24	27	30	MHZ
Hsync cycle	1/th	---	17.14	---	KHZ
Vsync cycle	1/tv	---	59.94	---	Hz
Horizontal Signal					
Horizontal cycle	th	1575	1575	1815	CLK
Horizontal display period	thd	1440	1440	1440	CLK
Horizontal front porch	thf	6	6	246	CLK
Horizontal pulse width	thp	6	123	123	CLK
Horizontal back porch	thb	6	6	123	CLK
Vertical signal					
Vertical cycle	tv	285	286	399	H(3)
Vertical display period	tvd	272	272	272	H(3)
Vertical front porch	tvf	1	2	227	H(3)
Vertical pulse width	tvp	1	10	11	H(3)
Vertical back porch	tvb	1	2	11	H(3)

Note(3) Unit: CLK=1/ Fclk,H=th

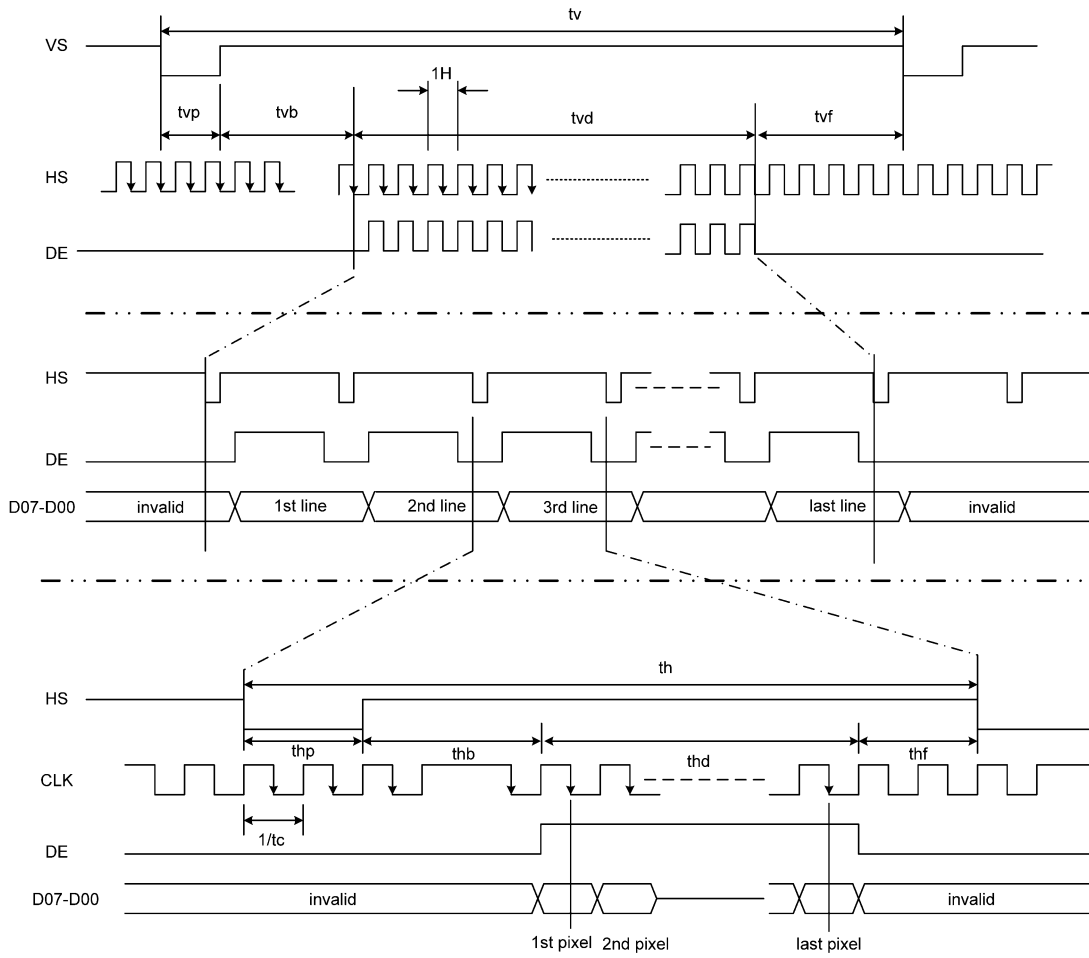

■ BACKLIGHT

▼ Backlight Type

Backlight Type: LED (Everlight L8085SGU or Equivalent)

▼ Power Supply For Backlight

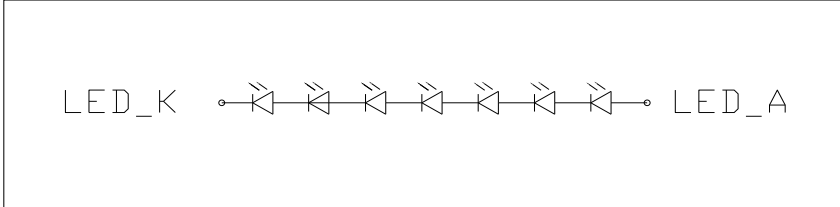

▼ Absolute Maximum Rating

PARAMETER	SYMBOL	CONDITION	MAX	UNIT
Absolute maximum forward current	Ifm		20	Ma
Peak forward current	Ifp	1 MSEC plus 10% Duty Cycle	15	mA
Reverse voltage	VR		3.3	V
Life	Hour	If(forward current) =160mA	30000	H

Note: For operation above 25°C, Then Ifm Ifp must be decreased, the Current decreased is -1.08mA/°C for DC drive and -2.58mA/°C Pulse drive, the power dissipation is -4.5mW/°C. The product working current must not more than the 70% of the Ifm or Ifp according to the working temperature.

▼ Electrical-Optical Characteristics

PARAMETER	SYMBOL	CONDITION	MIN	TYP	MAX	UNIT
Forward voltage	Vf (LED(+)-LED(-))		19.2	21.7	24.5	V
Forward current	If		----	15	20	mA
Reverse current	Ir	VR=3.3V	----	----	160	μA
Wavelength (Chromaticity)	λp		----	----	----	
Luminance	Lv	If(forward current) = 20mA	3000	----		cd/m ²

Note: The Master Screen's luminance is the average value of 5 points, and The Lvmin./Lvmax. is not less than 70%. The measurement instrument is BM-7 luminance Colorimeter. The aperture is Φ5 mm.

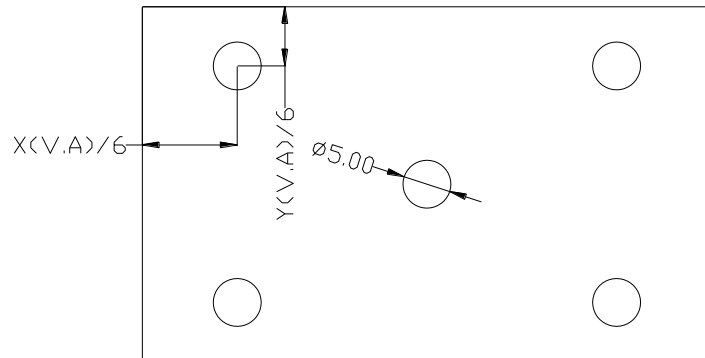

■ OPTICAL CHARACTERISTICS

(Ta = 25 °C, If = 20 mA, VL= 19.2 V)

Item		Symbol	Condition	Min	Typ.	Max	Unit	Remark	
Viewing Angle	Horizontal	ΘL	Center CR≥10	50	60	---	Deg.	Note 3,2	
		ΘR		50	60	---			
	Vertical	ΘU		50	50	---			
		ΘD		30	60	---			
Contrast Ratio		CR	At optimized View Angle	250	350	---	---	Note 1,4	
Luminance		YL	Θ=0°	200	240	---	cd/m ²	Note 1,5	
Uniformity		LU		50	62	---	%	Note 1,6	
Response Time		Tr	Θ=0°	---	15	20	ms	Note 7	
		Tf		---	15	30	ms		
Color Chromaticity	White	X	Θ=0°	-0.05	+0.05	---	---	---	
		Y							0.303
	Red	X							0.325
		Y							0.626
	Green	X							0.334
		Y							0.277
	Blue	X							0.549
		Y							0.142

Note 1: Measuring equipments: DMS-501, PR-705.

Measuring condition:

- After stabilizing and leaving the panel alone at a given temperature for 30 min, the measurement should be executed,
- Measuring surroundings: a stable, windless and dark room,
- Measuring temperature: Ta=25 °C,
- 30 min after lighting the back-light.

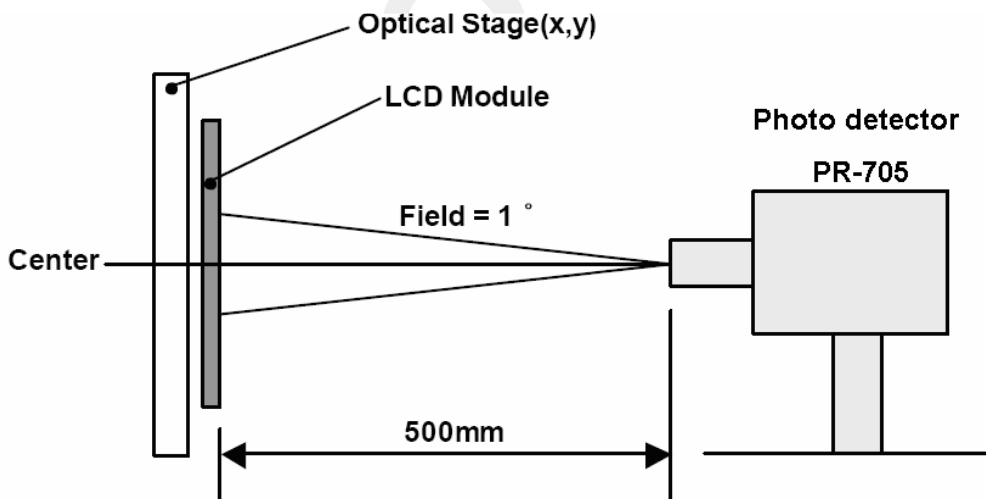

Note 2: The definition of viewing angle:

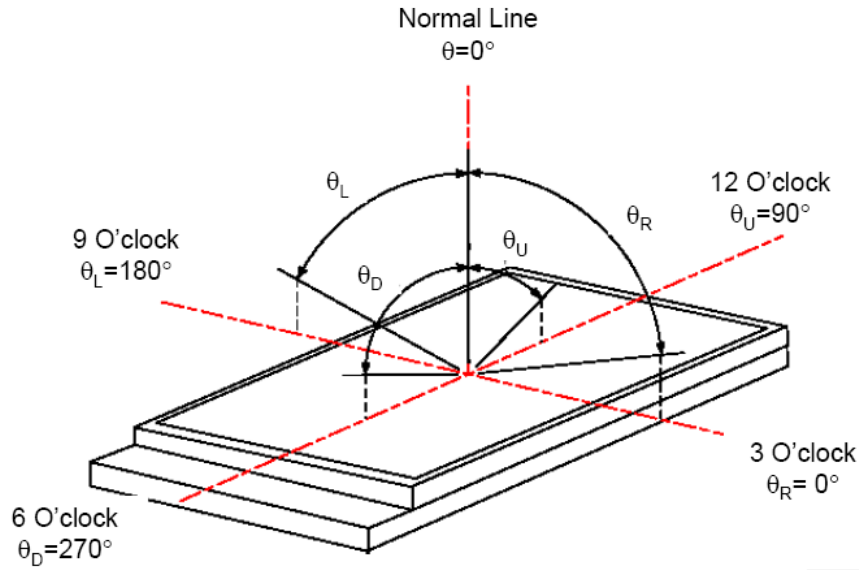

Note 3: The definition of viewing direction:

The definition of viewing direction is for good image quality, which is 12 O'clock. View Direction for Largest Contrast Ratio is 6 O'clock.

Note 4: The contrast ratio (CR) is defined as follows:

$$CR = \frac{\text{Luminance with all pixels white}}{\text{Luminance with all pixels black}}$$

Measure the luminance at the center of the screen.

Note 5: Definition luminance of White: measure the luminance of White at the center of the screen.

Note 6: The definition of luminance uniformity:

The luminance uniformity is calculated by using following formula.

$$\text{Luminance uniformity (Lu)} = \frac{\text{Minimum luminance from 1 to 9}}{\text{Maximum luminance from 1 to 9}}$$

The luminance is measured at near the 9 points shown below.

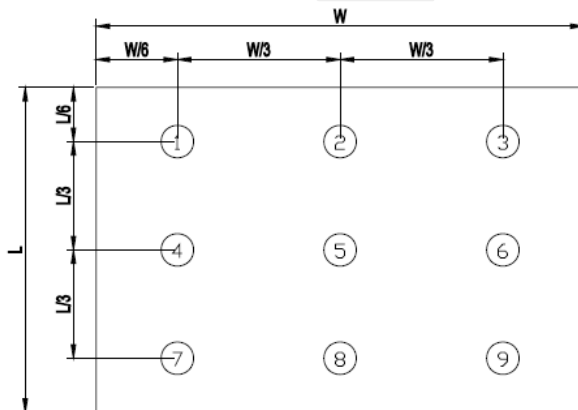

Note7: The definition of response time:

The output signals of photo detector are measured when the input signals are changed from “black” to “white” (falling time) and from “white” to “black” (rising time), respectively. The response time is defined as the time interval between the 10% and 90% of amplitudes. Refer to figure as below:

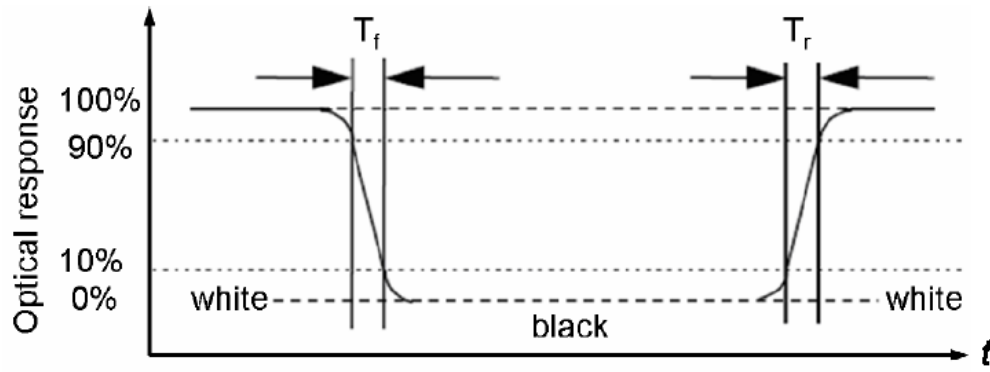

■ RELIABILITY

▼ Content of Reliability Test

Environmental Test				
No.	Test Item	Content of Test	Test Condition	Applicable Standard
1	High temperature storage	Endurance test applying the high storage temperature for a long time.	80 °C 200 hrs	----
2	Low temperature storage	Endurance test applying the low storage temperature for a long time.	-30 °C 200 hrs	----
3	High temperature operation	Endurance test applying the electric stress (Voltage & Current) and the thermal stress to the element for a long time.	70 °C 200 hrs	----
4	Low temperature operation	Endurance test applying the electric stress under low temperature for a long time.	-20 °C 200 hrs	----
5	High temperature / Humidity storage	Endurance test applying the high temperature and high humidity storage for a long time.	50 °C , 90 %RH 96 hrs	MIL-202E-103B JIS-C5023
6	High temperature / Humidity operation	Endurance test applying the electric stress (Voltage & Current) and temperature / humidity stress to the element for a long time.	40 °C 90 %RH 96 hrs	MIL-202E-103B JIS-C5023
7	Temperature cycle	Endurance test applying the low and high temperature cycle. $\begin{array}{c} -20^{\circ}\text{C} \quad \rightleftharpoons \quad 25^{\circ}\text{C} \quad \rightleftharpoons \quad 70^{\circ}\text{C} \\ \leftarrow \quad 30\text{min.} \quad \rightleftharpoons \quad 5\text{min.} \quad \rightleftharpoons \quad 30\text{min.} \quad \rightarrow \\ \text{1 cycle} \end{array}$	-20°C / 70°C 10 cycles	----
Mechanical Test				
8	Vibration test	Endurance test applying the vibration during transportation and using.	10~22Hz → 1.5mmp-p 22~500Hz → 1.5G Total 0.5hrs	MIL-202E-201A JIS-C5025 JIS-C7022-A-10
9	Shock test	Constructional and mechanical endurance test applying the shock during transportation.	50G half sign wave 11 msdc 3 times of each direction	MIL-202E-213B
10	Atmospheric pressure test	Endurance test applying the atmospheric pressure during transportation by air.	115 mbar 40 hrs	MIL-202E-105C
Others				
11	Static electricity test	Endurance test applying the electric stress to the terminal.	VS=800V , RS=1.5 kΩ CS=100 pF 1 time	MIL-883B-3015.1

*** Supply voltage for logic system = 5V. Supply voltage for LCD system = Operating voltage at 25°C.

▼ Failure Judgement Criterion



Criterion Item	Test Item No.											Failure Judgment Criterion	
	1	2	3	4	5	6	7	8	9	10	11		
Basic specification													Out of the Basic Specification
Electrical characteristic													Out of the DC and AC Characteristic
Mechanical characteristic													Out of the Mechanical Specification Color change : Out of Limit Apperance Specification
Optical characteristic													Out of the Apperance Standard

■ INSPECTION CRITERIA

Class	Item	Judgment	Class
Packing & Indicate	1.Outside and inside package	"Model no." , "lot no." and "quantity" Should indicate on the package.	Minor
	2.Model mixed and quantity	Other model mixed.....rejected. Quantity short or over....rejected.	Critical
	3.Product indication	"Model no." should indicate on the product	Major
Assembly	4.Dimension,LCD glass scratch And scribe defect	According to specification or drawing	Major
Appearance	5.Viewing area	Polarizer edge or LCD's sealing line is visible in the viewing arearejected	Minor
	6.Blemish、black spot、 White spot in the LCD And LCD glass cracks	According to standard of visual inspection (inside viewing area)	Minor
	7. Blemish、black spot White spot and scratch on the polarizer	According to standard of visual inspection (inside viewing area)	Minor
	8.Bubble in polarizer	According to standard of visual inspection (inside viewing area)	Minor
	9.LCD's rainbow color	Strong deviation color (or Newton ring) of LCDrejected. Or according to limited sample (if needed, and inside viewing area)	Minor
	10.FPC	Burned area or wrong part number is on FPC. The symbol, character, and mark of FPC are unidentifiable. The stripped solder mask, A>1.0mm 0.3mm < stripped solder mask or visible circuit, A<1.0mm,and the number is ≧ 4 pieces. Particle between circuits in solder mask.. Circuit is peeled off or cracked. Any circuit risen or exposed. 0.2mm< Area of solder ball, A is ≧ 0.4mm,the number of solder ball is ≧ 3 pieces. The magnitude of solder ball, A is>0.4mm.	Minor

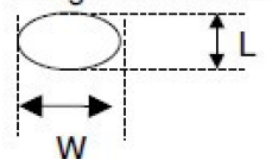
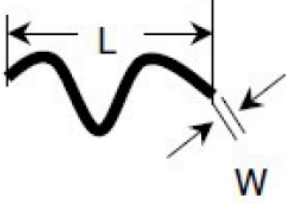
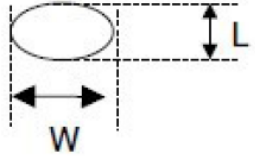
Class	Item	Judgment	Class
Electrical	11.Electrical and optical characteristics (contrast 、 VOP 、 chromaticity...etc)	According to specification or drawing. (inside viewing area)	Critical
	12.Missing pattern	Missing dot、 line、 character.....rejected	Critical
	13.Short circuit、 wrong pattern display	Non display 、 wrong pattern display 、 current consumption out of specification.....rejected	Critical
	14.Pin hole、 pattern deformity	According to standard of visual inspection	Minor
	15.Black spot、 white spot、 black line、 white line、 slant line、 background uneven 、 color uneven	Strong deviation color.....rejected Or according to limited sample full off screen (all black) ...disregards	Minor
	16.Stick image (retention image)	Fixed test picture within two hours...rejected	Minor

NO	Defect	Criteria		Remark
		Spec	Permissible Qty	
1	Round type(Minor)	$\phi \leq 0.10\text{mm}$	Disregard	1. $\phi = (L+W)/2$, L: Length, W: Width 2. Disregard if out of A.A. 
		$0.10\text{mm} < \phi \leq 0.20\text{mm}$	3	
		$0.20\text{mm} < \phi$	0	
2	Line type(Minor)	$W \leq 0.03\text{mm}$	Disregard	1. L: Length, W: Width 2. Disregard if out of A.A. 
		$L \leq 3.0\text{mm}$ and $0.03\text{mm} < W \leq 0.05\text{mm}$	2	
		$L \leq 3.0\text{mm}$ and $0.05\text{mm} < W \leq 0.10\text{mm}$	1	
		$W > 0.10\text{mm}$ or $L > 3.0\text{mm}$	0	
3	Polarizer dent(Minor)	$\phi \leq 0.20\text{mm}$	Disregard	1. $\phi = (L+W)/2$, L: Length, W: Width 2. Disregard if out of A.A. 
		$0.20\text{mm} < \phi \leq 0.30\text{mm}$	2	
		$0.30\text{mm} < \phi \leq 0.50\text{mm}$	1	
		$0.50\text{mm} < \phi$	0	

NO	Defect	Criteria		Remark
1	No display (Major)	Not allowed		
2	Missing line (Major)	Not allowed		
3	Darker or lighter Line (Major)	Not allowed		
4	Weak line(Major)	By limited sample		
5	Bright / Dark point (Minor)	Spec.	Permissible Qty	1:1sub-pixel: 1R or 1G or 1B 2:Point defect area \geq 1/2 sub pixel.
		Bright point	1	
		Dark point	2	

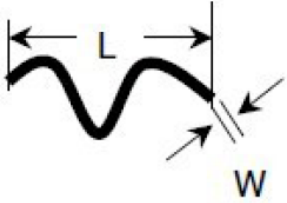
6	Round type (Minor)	Spec	Permissible Qty	1. $\phi = (L+W)/2$, L: Length, W: Width 2. Disregard if out of A.A. 
		$\phi \leq 0.10\text{mm}$	Disregard	
		$0.10\text{mm} < \phi \leq 0.20\text{mm}$	3	
		$0.20\text{mm} < \phi$	0	
7	Line type (Minor)	Spec.	Permissible Qty	1. L: Length, W: Width 2. Disregard if out of A.A. 
		$W \leq 0.03\text{mm}$	Disregard	
		$L \leq 3.0\text{mm}$ and $0.03\text{mm} < W \leq 0.05\text{mm}$	2	
		$L \leq 3.0\text{mm}$ and $0.05\text{mm} < W \leq 0.10\text{mm}$	1	
		$W > 0.10\text{mm}$ or $L > 3.0\text{mm}$	0	
8	Mura (Minor)	By 5% ND filter invisible		

■ PRECAUTIONS FOR USING LCD MODULES

▼ Handling Precautions

- (1) The display panel is made of glass. Do not subject it to a mechanical shock by dropping it or impact.
- (2) If the display panel is damaged and the liquid crystal substance leaks out, be sure not to get any in your mouth. If the substance contacts your skin or clothes, wash it off using soap and water.
- (3) Do not apply excessive force to the display surface or the adjoining areas since this may cause the color tone to vary.
- (4) The polarizer covering the display surface of the LCD module is soft and easily scratched. Handle this polarizer carefully.
- (5) If the display surface becomes contaminated, breathe on the surface and gently wipe it with a soft dry cloth. If it is heavily contaminated, moisten cloth with one of the following solvents :
 - Isopropyl alcohol
 - Ethyl alcohol
- (6) Solvents other than those above-mentioned may damage the polarizer. Especially, do not use the following.
 - Water
 - Ketone
 - Aromatic solvents
- (7) Exercise care to minimize corrosion of the electrode. Corrosion of the electrodes is accelerated by water droplets, moisture condensation or a current flow in a high-humidity environment.

■ USING LCD MODULES

▼ Liquid Crystal Display Modules

LCD is composed of glass and polarizer. Pay attention to the following items when handling.

- (1) Please keep the temperature within specified range for use and storage. Polarization degradation, bubble generation or polarizer peel-off may occur with high temperature and high humidity.
- (2) Do not touch, push or rub the exposed polarizers with anything harder than an HB pencil lead (glass, tweezers, etc.).
- (3) N-hexane is recommended for cleaning the adhesives used to attach front/rear polarizers and reflectors made of organic substances which will be damaged by chemicals such as acetone, toluene, ethanol and isopropylalcohol.
- (4) When the display surface becomes dusty, wipe gently with absorbent cotton or other soft material like chamois soaked in petroleum benzin. Do not scrub hard to avoid damaging the display surface.
- (5) Wipe off saliva or water drops immediately, contact with water over a long period of time may cause deformation or color fading.
- (6) Avoid contacting oil and fats.
- (7) Condensation on the surface and contact with terminals due to cold will damage, stain or dirty the polarizers. After products are tested at low temperature they must be warmed up in a container before coming is contacting with room temperature air.
- (8) Do not put or attach anything on the display area to avoid leaving marks on.
- (9) Do not touch the display with bare hands. This will stain the display area and degradate insulation between terminals (some cosmetics are determinated to the polarizers).
- (10) As glass is fragile. It tends to become or chipped during handling especially on the edges. Please avoid dropping or jarring.

▼ Installing LCD Modules

The hole in the printed circuit board is used to fix LCM as shown in the picture below. Attend to the following items when installing the LCM.

- (1) Cover the surface with a transparent protective plate to protect the polarizer and LC cell.

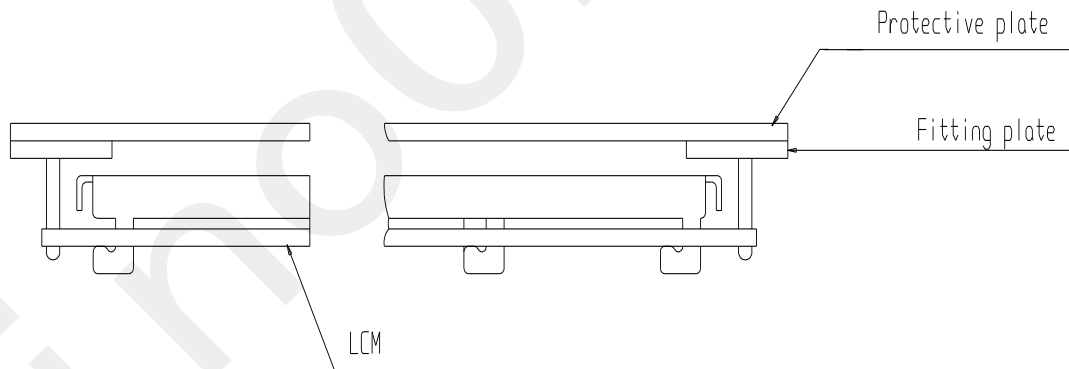

- (2) When assembling the LCM into other equipment, the spacer to the bit between the LCM and the fitting plate should have enough height to avoid causing stress to the module surface, refer to the individual specifications for measurements. The measurement tolerance should be $\pm 0.1\text{mm}$.

▼ Precaution for Handing LCD Modules

Since LCM has been assembled and adjusted with a high degree of precision, avoid applying excessive shocks to the module or making any alterations or modifications to it.

- (1) Do not alter, modify or change the shape of the tab on the metal frame.
- (2) Do not make extra holes on the printed circuit board, modify its shape or change the positions of components to be attached.
- (3) Do not damage or modify the pattern writing on the printed circuit board.
- (4) Absolutely do not modify the zebra rubber strip (conductive rubber) or heat seal connector.

(5) Except for soldering the interface, do not make any alterations or modifications with a soldering iron.

(6) Do not drop, bend or twist LCM.

▼ **Electro-Static Discharge Control**

Since this module uses a CMOS LSI, the same careful attention should be paid to electrostatic discharge as for an ordinary CMOS IC.

(1) Make certain that you are grounded when handling LCM.

(2) Before remove LCM from its packing case or incorporating it into a set, be sure the module and your body have the same electric potential.

(3) When soldering the terminal of LCM, make certain the AC power source for the soldering iron does not leak.

(4) When using an electric screwdriver to attach LCM, the screwdriver should be of ground potentiality to minimize as much as possible any transmission of electromagnetic waves produced sparks coming from the commutator of the motor.

(5) As far as possible make the electric potential of your work clothes and that of the work bench the ground potential.

(6) To reduce the generation of static electricity be careful that the air in the work is not too dried. A relative humidity of 50%-60% is recommended.

▼ **Precaution for soldering to the LCM**

(1) Observe the following when soldering lead wire, connector cable and etc. to the LCM.

- Soldering iron temperature : $280^{\circ}\text{C} \pm 10^{\circ}\text{C}$.

- Soldering time : 3-4 sec.

- Solder : eutectic solder.

If soldering flux is used, be sure to remove any remaining flux after finishing to soldering operation. (This does not apply in the case of a non-halogen type of flux.) It is recommended that you protect the LCD surface with a cover during soldering to prevent any damage due to flux spatters.

(2) When soldering the electroluminescent panel and PC board, the panel and board should not be detached more than three times. This maximum number is determined by the temperature and time conditions mentioned above, though there may be some variance depending on the temperature of the soldering iron.

(3) When remove the electroluminescent panel from the PC board, be sure the solder has completely melted, the soldered pad on the PC board could be damaged.

▼ **Precautions for Operation**

(1) Viewing angle varies with the change of liquid crystal driving voltage (VO). Adjust VO to show the best contrast.

(2) Driving the LCD in the voltage above the limit shortens its life.

(3) Response time is greatly delayed at temperature below the operating temperature range. However, this does not mean the LCD will be out of the order. It will recover when it returns to the specified temperature range.

(4) If the display area is pushed hard during operation, the display will become abnormal. However, it will return to normal if it is turned off and then back on.

(5) Condensation on terminals can cause an electrochemical reaction disrupting the terminal circuit. Therefore, it must be used under the relative condition of 40°C , 50% RH.

(6) When turning the power on, input each signal after the positive/negative voltage becomes stable.

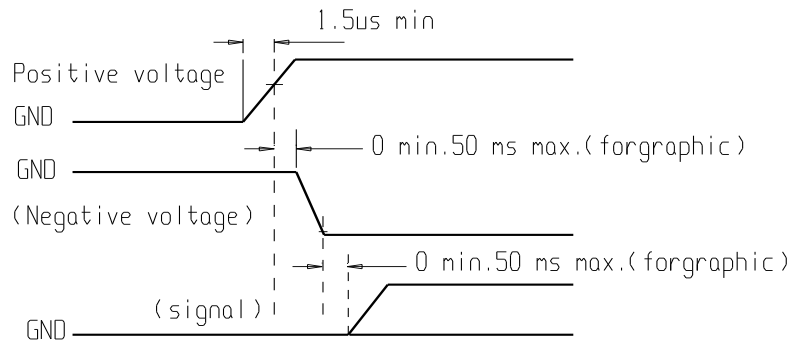

▼ Storage

When storing LCD's as spares for some years, the following precaution are necessary.

- (1) Store them in a sealed polyethylene bag. If properly sealed, there is no need for dessicant.
- (2) Store them in a dark place. Do not expose to sunlight or fluorescent light, keep the temperature between 0°C and 35°C.
- (3) The polarizer surface should not come in contact with any other objects. (We advise you to store them in the container in which they were shipped.)
- (4) Environmental conditions :
 - Do not leave them for more than 168hrs. at 80°C.
 - Should not be left for more than 48hrs. at -30°C.

▼ Safety

- (1) It is recommended to crush damaged or unnecessary LCD's into pieces and wash them off with solvents such as acetone and ethanol, which should later be burned.
- (2) If any liquid out of a damaged glass cell and comes in contact with the hands, wash off thoroughly with soap and water.

▼ Limited Warranty

Unless agreed between SINO and customer, SINO will replace or repair any of its LCD modules which are found to be functionally defective when inspected in accordance with SINO LCD acceptance standards (copies available upon request) for a period of one year from date of shipments. Cosmetic/visual defects must be returned to SINO within 90 days of shipment. Confirmation of such date shall be based on freight documents. The warranty liability of SINO limited to repair and/or replacement on the terms set forth above. SINO will not be responsible for any subsequent or consequential events.

▼ Return LCM under warranty

No warranty can be granted if the precautions stated above have been disregarded. The typical examples of violations are :

- Broken LCD glass.
- PCB eyelet's damaged or modified.
- PCB conductors damaged.
- Circuit modified in any way, including addition of components.
- PCB tampered with by grinding, engraving or painting varnish.
- soldering to or modifying the bezel in any manner.

Module repairs will be invoiced to the customer upon mutual agreement. Modules must be returned with sufficient description of the failures or defects. Any connectors or cable installed by the customer must be removed completely without damaging the PCB eyelet's, conductors and terminals.